

Case Material:PC; Brand: Sabc,USA; Fire Protection:94V-0

With or without LED indicate can be choice

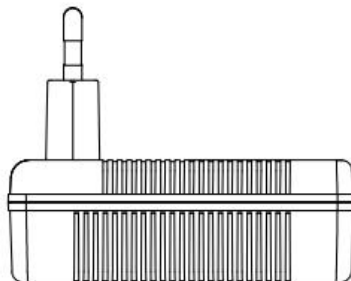

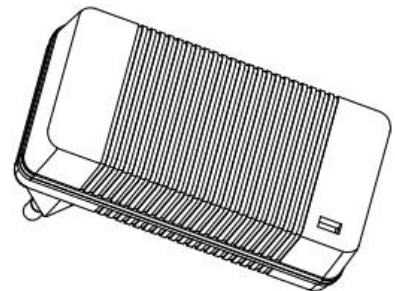
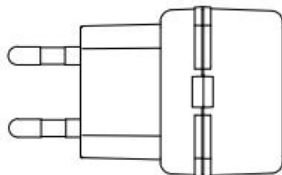
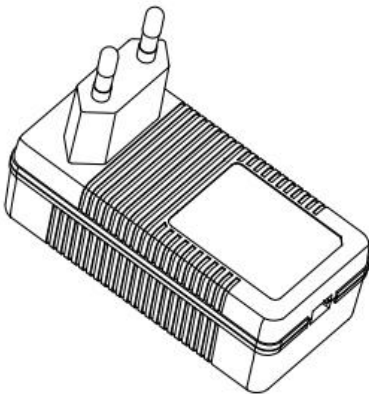
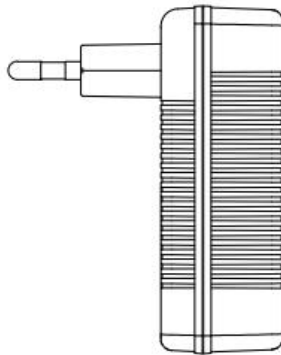
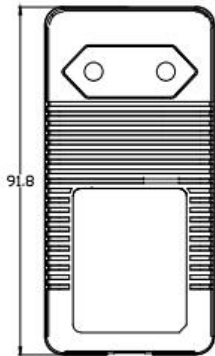
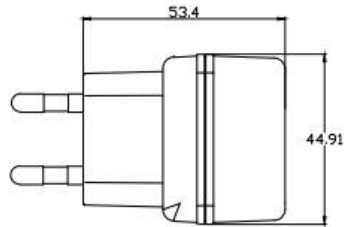
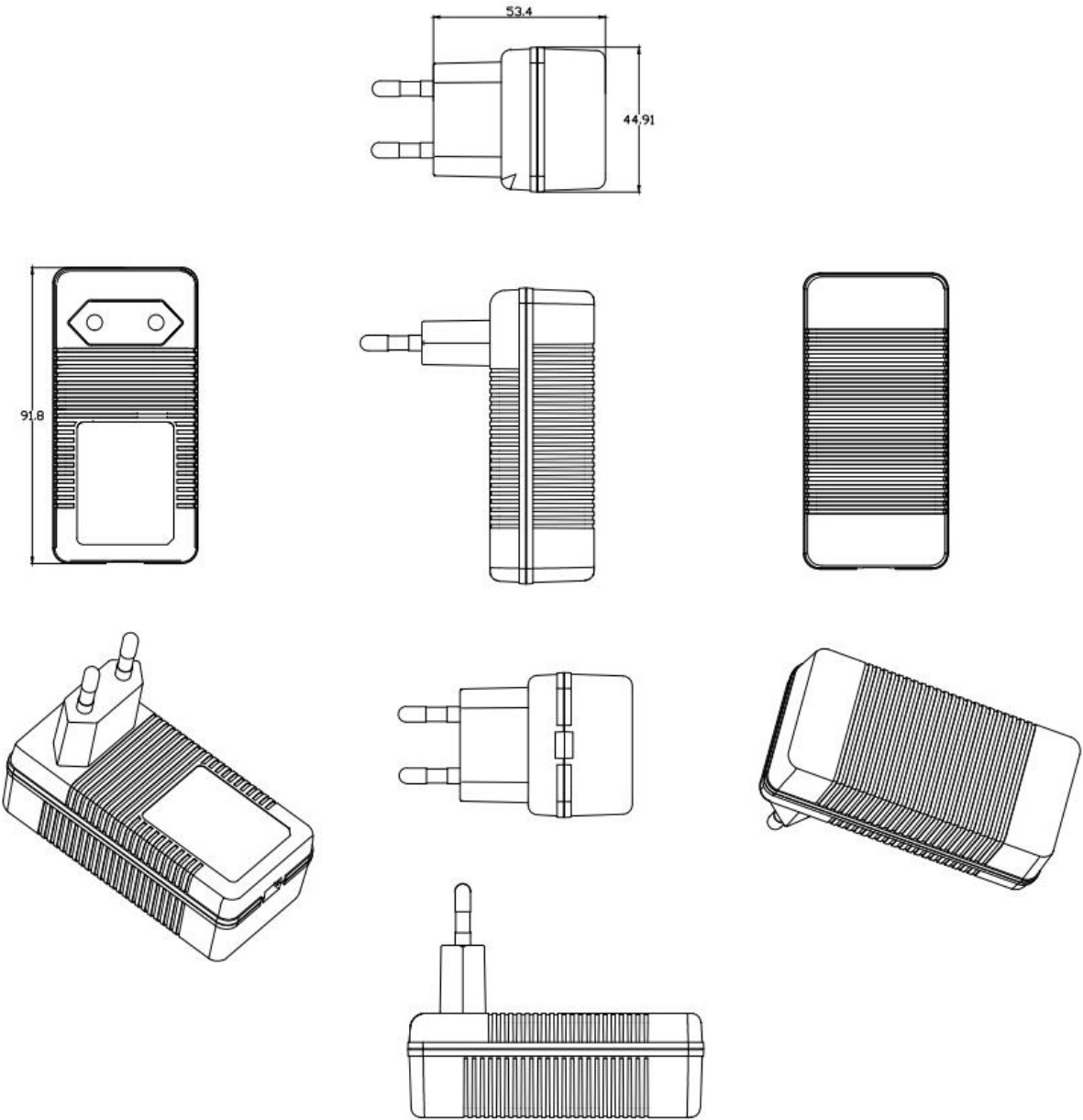

Xinsu Global Electronic Co.,Limited TEL:86-0755-29706858

www.xinsuglobal.com

Email:sale@xinsuglobal.com